

Price List OF - 1800 - Drainage  
Effective September 2, 2008  
Supersedes all previous price lists.

**ORION**  
**ORION FITTINGS**

# PRICE GUIDE

**OF-1800**

## Polypropylene & PVDF Drainage Systems



## Table of Contents

<u>No Hub/Plain End &amp; Rionfuse CF Polypropylene Acid Waste</u>	3
<u>Combination Stainless Steel and Polypropylene Floor Drains and Cleanouts</u>	11
<u>Large Diameter Polypropylene Plain End Fittings (8" - 12")</u>	12
<u>Socket Fusion Polypropylene Acid Waste</u>	15
<u>PVDF No Hub/Rionfuse CF "Super Blue" Acid Waste</u>	21
<u>PVDF Socket Fusion "Super Blue" Acid Waste</u>	25
<u>Laboratory Sinks</u>	29
<u>Neutralization &amp; Dilution Tanks</u>	30
<u>Neutraguard Monitoring Systems</u>	36
<u>Tools</u>	38
<u>Terms and Conditions of Sale</u>	40

# No-Hub/Rionfuse Polypropylene Acid Waste Drainage



Pipe Cut Charge	
1 1/2" - 6" - \$5.00/Cut	8" & Larger - \$10.00/Cut

## Pipe Priced Per 100 Feet

### Blueline Polypropylene Schedule 40

Size	Part #	Price
1-1/2"	0110156440	\$1,176.00
2"	0110206440	\$1,614.00
3"	0110306440	\$2,922.00
4"	0110406440	\$4,146.00
6"	0110606440	\$7,016.00
8"	0110806440	\$15,638.00
10"	0111006440	\$16,862.00
12"	0111206440	\$20,727.00

### Blueline Polypropylene Schedule 80

Size	Part #	Price
1-1/2"	0110156480	\$1,671.00
2"	0110206480	\$2,079.00
3"	0110306480	\$3,961.00
4"	0110406480	\$5,186.00
6"	0110606480	\$11,001.00
8"	0110606480	P.O.A
10"	0110606480	P.O.A
12"	0110606480	P.O.A

### Brownline Polypropylene Schedule 40

Size	Part #	Price
1-1/2"	0120156440	\$759.00
2"	0120206440	\$1,026.00
3"	0120306440	\$2,106.00
4"	0120406440	\$2,680.00
6"	0120606440	\$5,368.00

### Brownline Polypropylene Schedule 80

Size	Part #	Price
1-1/2"	0120156480	\$1,207.00
2"	0120206480	\$1,571.00
3"	0120306480	\$2,890.00
4"	0120406480	\$4,049.00
6"	0120606480	\$7,774.00

Prices are per 100 feet. All pipe is non-returnable.



### No-Hub\* Coupling

Size	Part #	Price
1-1/2"	11101501	\$11.20
2"	11102001	\$14.40
3"	11103001	\$21.70
4"	11104001	\$37.70
6"	11106001	\$68.10

\*Mechanical Joint



### RF CF\* Coupling

Size	Part #	Price
1-1/2"	131101501	\$17.10
2"	131102001	\$21.40
3"	131103001	\$25.60
4"	131104001	\$34.20
6"	131106001	\$96.80

\*Rionfuse Clamp Free



### 90° Elbow - 1/4 Bend

Size	Part #	Price
1-1/2"	01101503	\$20.90
2"	01102003	\$25.30
3"	01103003	\$60.10
4"	01104003	\$112.70
6"	01106003	\$235.10

See page 9 for long sweep 90s



### 45° Elbow - 1/8 bend

Size	Part #	Price
1-1/2"	01101502	\$19.20
2"	01102002	\$23.50
3"	01103002	\$61.90
4"	01104002	\$108.30
6"	01106002	\$162.90

**Note: All Fittings Are Sold As Plain End. Couplings Must Be Purchased Separately.**

Prices Subject to change without notice. Possession of this price list shall not be construed as an offer to sell to the bearer.



**Sanitary Tee - 90 Tee**

Size	Part #	Price
1-1/2"	01101505	\$28.20
2"	01102005	\$51.10
3"	01103005	\$79.70
4"	01104005	\$132.30

For 6", use long turn wye



**Clean Out Tee With Plug**

Size	Part #	Price
1-1/2"	01101507	\$58.90
2"	01102007	\$74.30
3"	01103007	\$128.80
4"	01104007	\$180.60
*6"	01106007	\$606.10



**Reducing Wye**

Size	Part #	Price
2" x 1-1/2"	011021509	\$44.80
3" x 1-1/2"	011031509	\$112.30
3" x 2"	011030209	\$128.50
4" x 1-1/2"	011041509	\$200.60
4" x 2"	011040209	\$210.50
4" x 3"	011040309	\$227.70
*6" x 2"	011060209	\$291.60
*6" x 3"	011060309	\$334.30
*6" x 4"	011060409	\$455.20



**Reducing Long Turn Wye**  
(Reducing Combo wye + 1/8 bend)

Size	Part #	Price
2" x 1-1/2"	011021511	\$56.80
3" x 1-1/2"	011031511	\$117.10
3" x 2"	011030211	\$129.90
4" x 1-1/2"	011041511	\$208.10
4" x 2"	011040211	\$222.50
4" x 3"	011040311	\$236.50
*6" x 2"	011060211	\$382.50
*6" x 3"	011060311	\$426.60
*6" x 4"	011060411	\$462.20



**Reducing Sanitary Tee**

Size	Part #	Price
2" x 1-1/2"	011021506	\$28.60
3" x 1-1/2"	011031506	\$80.10
3" x 2"	011030206	\$95.60
4" x 1-1/2"	011041506	\$141.60
4" x 2"	011040206	\$149.40
4" x 3"	011040306	\$167.80

For 6", use long turn wye



**45° Wye**

Size	Part #	Price
1-1/2"	01101508	\$19.40
2"	01102008	\$33.10
3"	01103008	\$95.60
4"	01104008	\$142.00
*6"	01106008	\$305.80



**Long Turn Tee Wye**  
(combo wye + 1/8 bend)

Size	Part #	Price
1-1/2"	01101510	\$38.60
2"	01102010	\$53.10
3"	01103010	\$112.50
4"	01104010	\$163.70
*6"	01106010	\$561.80



**Upright Wye**

Size	Part #	Price
*1-1/2"	01101512	\$83.90
*2"	01102012	\$98.90
*3"	01103012	\$146.10
*4"	01104012	\$227.40

**Note: All Fittings Are Sold As Plain End. Couplings Must Be Purchased Separately.**  
 Prices Subject to change without notice, Possession of this price list shall not be construed as an offer to sell to the bearer.  
 \*Non-Cancelable, Non-Returnable



**Double Wye**

Size	Part #	Price
1-1/2"	01101513	\$78.10
2"	01102013	\$125.80
3"	01103013	\$175.90
4"	01104013	\$229.90
*6"	01106013	\$590.50



**Reducing Double Wye**

Size	Part #	Price
2" x 1-1/2"	011021514	\$219.10
3" x 1-1/2"	011031514	\$233.30
3" x 2"	011030214	\$247.40
4" x 1-1/2"	011041514	\$286.70
4" x 2"	011040214	\$291.60
4" x 3"	011040314	\$305.80
*6" x 2"	011060214	\$644.10
*6" x 3"	011060314	\$655.50
*6" x 4"	011060414	\$669.70



**Double Long Turn Tee Wye (combo wye+1/8 bend)**

Size	Part #	Price
1-1/2"	01101515	\$106.30
2"	01102015	\$156.50
3"	01103015	\$303.60
4"	01104015	\$396.50
*6"	01106015	\$932.10



**Reducing Double Long Turn Tee Wye (combo wye +1/8 bend)**

Size	Part #	Price
2" x 1-1/2"	011021516	\$167.80
3" x 1-1/2"	011031516	\$170.70
3" x 2"	011030216	\$193.40
4" x 1-1/2"	011041516	\$415.20
4" x 2"	011040216	\$426.80
4" x 3"	011040316	\$433.80
*6" x 2"	011060216	\$749.40
*6" x 3"	011060316	\$776.50
*6" x 4"	011060416	\$794.90



**Male Adapter - MA**

Size	Part #	Price
1-1/2"	01101517	\$17.10
2"	01102017	\$18.20
3"	01103017	\$41.30
4"	01104017	\$94.40
6"	01106017	\$218.00

Reducing Male adapters available. Contact Orion.



**Female Adapter - FA**

Size	Part #	Price
1-1/2"	01101518	\$19.00
2"	01102018	\$29.00
3"	01103018	\$61.90
4"	01104018	\$101.20
6"	01106018	\$216.50

Reducing Female adapters available. Contact Orion.



**Clean-Out Adapter With Plug**

Size	Part #	Price
1-1/2"	01101519	\$31.20
2"	01102019	\$48.30
3"	01103019	\$106.60
4"	01104019	\$163.20
6"	01106019	\$346.30



**Clean-Out Plug - CPC**

Size	Part #	Price
1-1/2"	01101520	\$12.20
2"	01102020	\$19.40
3"	01103020	\$44.70
4"	01104020	\$62.00
6"	01106020	\$129.80

Counter sunk plug available at same price. Add "CSK" at end of part#

**Note: All Fittings Are Sold As Plain End. Couplings Must Be Purchased Separately.**

Prices Subject to change without notice, Possession of this price list shall not be construed as an offer to sell to the bearer.

\*Non-Cancelable, Non-Returnable

**Cap**

Size	Part #	Price
1-1/2"	01101521	\$37.20
2"	01102021	\$41.00
3"	01103021	\$69.40
4"	01104021	\$109.60
6"	01106021	\$115.30

**Duriron x Spigot Adapter**

Size	Part #	Price
1-1/2"	01101523	\$47.30
2"	01102023	\$57.20
3"	01103023	\$63.90
4"	01104023	\$81.50
6"	01106023	\$149.00

**Cast Iron Hub Adapter**

Size	Part #	Price
*1-1/2"	01101524	\$47.30
*2"	01102024	\$57.20
*3"	01103024	\$63.90
*4"	01104024	\$81.50
*6"	01106024	\$130.10

**Running Trap - UTR**

Size	Part #	Price
*1-1/2"	01101526	\$112.90
*2"	01102026	\$175.70

**Reducing Bushing - RB**

Size	Part #	Price
2" x 1-1/2"	011021522	\$35.60
3" x 1-1/2"	011031522	\$38.40
3" x 2"	011030222	\$39.90
4" x 1-1/2"	011041522	\$75.10
4" x 2"	011040222	\$78.80
4" x 3"	011040322	\$81.30
6" x 2"	011060222	\$129.30
6" x 3"	011060322	\$133.50
6" x 4"	011060422	\$136.50

**Duriron Hub Adapter**

Size	Part #	Price
*1-1/2"	01101524	\$47.30
*2"	01102024	\$57.20
*3"	01103024	\$63.90
*4"	01104024	\$81.50
*6"	01106024	\$130.10

**P Trap - UTP**

Size	Part #	Price
1-1/2"	01101525	\$97.40
2"	01102025	\$158.80

**S Trap - UTP S**

Size	Part #	Price
*1-1/2"	01101527	\$125.50
*2"	01102027	\$199.80

**Note: All Fittings Are Sold As Plain End. Couplings Must Be Purchased Separately.**

Prices Subject to change without notice, Possession of this price list shall not be construed as an offer to sell to the bearer.

\*Non-Cancelable, Non-Returnable



**P Trap - RBP**

Size	Part #	Price
*1-1/2"	01101528	\$67.30
*2"	01102028	\$89.30
3"	01103028	\$178.70
4"	01104028	\$381.60
*6"	01106028	\$959.90



**S Trap - RPB S**

Size	Part #	Price
*1-1/2"	01101529	\$91.00
*2"	01102029	\$111.20
*3"	01103029	\$331.10
*4"	01104029	\$450.10



**RLNS**

Size	Part #	Price
1-1/2"	01101530	\$44.20
2"	01102030	\$61.50



**Sink Tail Piece  
Extension RLNS x 12"**

Size	Part #	Price
1-1/2"	01101531	\$77.40
2"	01102031	\$88.20



**Slip Joint Adapter**

Size	Part #	Price
1-1/2"	01101532	\$43.20
2"	01102032	\$50.10



**Slip Joint Adapter  
Extension SJA x 12"**

Size	Part #	Price
1-1/2"	01101533	\$81.60
2"	01102033	\$89.70



**Flange - FLG**

Size	Part #	Price
1-1/2"	01101535	\$134.50
2"	01102035	\$155.70
3"	01103035	\$253.50
4"	01104035	\$311.60
6"	01106035	\$406.80

Blind flange available



**Backing Ring**

Size	Part #	Price
1-1/2"	04001536	\$63.80
2"	04002036	\$70.60
3"	04003036	\$93.00
4"	04004036	\$111.70
6"	04006036	\$122.60

**Note: All Fittings Are Sold As Plain End. Couplings Must Be Purchased Separately.**

Prices Subject to change without notice, Possession of this price list shall not be construed as an offer to sell to the bearer.

\*Non-Cancelable, Non-Returnable



**\*Bottle Trap**

Size	Part #	Price
*BT - 1	01101537	\$107.00
BT - 2 w. pt bottle	01101581	\$126.50
*BT - 3	01101582	\$165.10
BT - 4 w. pt bottle	01101593	\$143.70
1 Pt.	01450076	\$58.40
1 Qt.	01451076	\$63.60
2 Qt.	01452076	\$71.10

\*Does not include bottle



**Swivel Drum Trap**

Size	Part #	Price
1-1/2"	01101538	\$248.30
2"	01102038	\$259.60



**Waste Assemblies**

Size	Part #	Price
WA-1, 1 1/2" IPS	WA-1	\$61.40
WA-2, 1 1/2" IPS	WA-2	\$67.30
WA-3, 1 1/2" IPS	WA-3	\$85.50
WA-4, 1 1/2" IPS	WA-4	\$89.10
WA-5, 2" IPS	WA-5	\$92.50



**Standing Waste Assemblies**

Size	Part #	Price
<b>OPEN TOP</b>		
*6" Long	01306040OT	\$19.20
*10" Long	01310040OT	\$21.30
<b>CLOSED TOP</b>		
*6" Long	01306040CT	\$32.60
*10" Long	01310040CT	\$47.70

To fit waste assembly outlets.



**Cup Sink - Oval**

Size	Part #	Price
CS1 - 6" x 3" x 4"	81363441	\$86.50
**CS2 - 6" x 3" x 4"	81363441-1	\$104.90
CS5 - 9" x 3" x 4"	81393441	\$98.00
**CS6 - 9" x 3" x 4"	81393441-1	\$116.30

\*\*Side outlet



**Cup Sink - Round**

Size	Part #	Price
CS3 6" x 3"	81306342	\$75.90



**Cup Sink - Fast Flow**

Size	Part #	Price
CS7 6" x Taper	81300643	\$64.50

**Repair Coupling**

Size	Part #	Price
1-1/2"	131101501-R	\$17.10
2"	131102001-R	\$21.40
3"	131103001-R	\$25.60
4"	131104001-R	\$34.20
6"	131106001-R	\$96.80

**Note: All Fittings Are Sold As Plain End. Couplings Must Be Purchased Separately.**

Prices Subject to change without notice, Possession of this price list shall not be construed as an offer to sell to the bearer.

\*Non-Cancelable, Non-Returnable



**Double Sanitary Tee**

Size	Part #	Price
*1-1/2"	01101579	\$177.80
*2"	01102079	\$248.90
*3"	01103079	\$334.20
*4"	01104079	\$504.90



**Long Sweep 90**

Size	Part #	Price
1-1/2"	01101504	\$52.40
2"	01102004	\$64.10
3"	01103004	\$148.50
4"	01104004	\$247.50
*6"	01106004	\$403.90



**Double Reducing Sanitary Tee**

Size	Part #	Price
*2" x 1-1/2"	011021580	\$270.20
*3" x 2"	011030280	\$348.40
*4" x 3"	011040380	\$433.80
*4" x 2	011040280	\$462.20



**Glass adapter x plain end**

Size	Part #	Price
*1-1/2"	011015100	\$56.90
*2"	011020100	\$73.90
*3"	011030100	\$121.00
*4"	011040100	\$167.80
*6"	011060100	\$223.30



**Acid Waste Floor Clean-Out**

Size	Part #	Price
<b>Brushed Bronze</b>		
3"	01103044SBB (square)	\$544.60
4"	01104044SBB (square)	\$587.30
3"	01103044RBB (round)	\$544.60
4"	01104044RBB (round)	\$587.30
<b>Nickle Bronze</b>		
3"	01103044SNB (square)	\$544.60
4"	01104044SNB (square)	\$587.30
3"	01103044RNB (round)	\$544.60
4"	01104044RNB (round)	\$587.30

*With adjustable top for finished floors*

**Note: All Fittings Are Sold As Plain End. Couplings Must Be Purchased Separately.**

Prices Subject to change without notice, Possession of this price list shall not be construed as an offer to sell to the bearer.

\*Non-Cancelable, Non-Returnable



**Floor Drain FD-1**

Size	Part #	Price
2"	01102045	\$527.80
3"	01103045	\$578.80
4"	01104045	\$629.20
*6"	01106045	\$772.10



**Side Outlet Floor Drain FD-2**

Size	Part #	Price
*2"	01102046	\$634.30
*3"	01103046	\$735.20
*4"	01104046	\$779.30



**Integral Trap Floor Drain - FD-3**

Size	Part #	Price
*2"	01102047	\$753.70
*3"	01103047	\$837.50
*4"	01104047	\$996.10

**Floor Drain Accessories**

Description	Part #	Price
*Funnel - 4" x 9"	01300065	\$94.70
*1/2" Trap Primer	01000066	\$64.10
*Connection FIP		
*Sediment Bucket	01300067	\$96.30
*Flashing Clamp	04000068	\$74.70
*Vandal Proofing	000000VP	\$108.90
*Solid Cover	01300069	\$121.60



**Floor Sink**

Size	Part #	Price
*2"	03102091	\$540.30
*3"	03103091	\$540.30
*4"	03104091	\$611.50

\* Non-Cancelable, Non-Returnable  
 Attention: Do not pressure test with compressed air or gas! Severe damage or bodily injury can result.  
 PRICES SUBJECT TO CHANGE WITHOUT NOTICE, POSSESSION OF THIS PRICE LIST SHALL NOT BE CONSTRUED AS AN OFFER TO SELL TO THE BEARER.

# Combination Stainless Steel and Polypropylene Floor Drains and Floor Sinks



**5" Round  
Stainless Strainer**

Size	Part #	Price
*2"	01102045-SSR5	\$1,066.50
*3"	01103045-SSR5	\$1,159.00
*4"	01104045-SSR5	\$1,258.50
*6"	01106045-SSR5	\$1,564.10



**6" Round  
Stainless Strainer**

Size	Part #	Price
*2"	01102045-SSR6	\$1,137.50
*3"	01103045-SSR6	\$1,230.10
*4"	01104045-SSR6	\$1,329.60
*6"	01106045-SSR6	\$1,635.20



**8" Round  
Stainless Strainer**

Size	Part #	Price
*2"	01102045-SSR8	\$1,208.70
*3"	01103045-SSR8	\$1,301.10
*4"	01104045-SSR8	\$1,400.70
*6"	01106045-SSR8	\$1,706.30

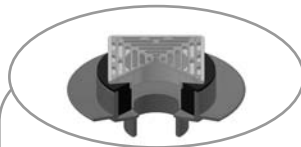

**5" x 5" Square  
Stainless Strainer**

Size	Part #	Price
*2"	01102045-SSS5	\$1,066.50
*3"	01103045-SSS5	\$1,159.00
*4"	01103045-SSS5	\$1,258.50
*6"	01106045-SSS5	\$1,564.10

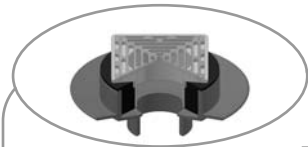

**6" x 6" Square  
Stainless Strainer**

Size	Part #	Price
*2"	01102045-SSS6	\$1,137.50
*3"	01103045-SSS6	\$1,230.10
*4"	01104045-SSS6	\$1,329.60
*6"	01106045-SSS6	\$1,635.20

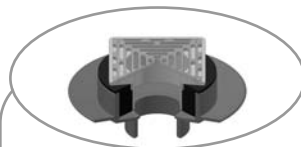

**8" x 8" Square  
Stainless Strainer**

Size	Part #	Price
*2"	01102045-SSS8	\$1,208.65
*3"	01103045-SSS8	\$1,301.10
*4"	01104045-SSS8	\$1,400.70
*6"	01106045-SSS8	\$1,706.30

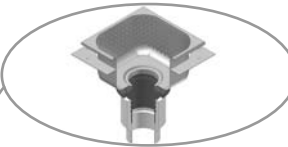

**12x12x6 Floor Sink with  
Stainless Strainer**

Size	Part #	Price
*2"	12126FS02-SS	P.O.A.
*3"	12126FS03-SS	P.O.A.
*4"	12126FS04-SS	P.O.A.
*6"	12126FS06-SS	P.O.A.



**12x12x8 Floor Sink with  
Stainless Strainer**

Size	Part #	Price
*2"	12128FS02-SS	P.O.A.
*3"	12128FS03-SS	P.O.A.
*4"	12128FS04-SS	P.O.A.
*6"	12128FS06-SS	P.O.A.

\* Non-Cancelable, Non-Returnable

Attention: Do not pressure test with compressed air or gas! Severe damage or bodily injury can result.

PRICES SUBJECT TO CHANGE WITHOUT NOTICE, POSSESSION OF THIS PRICE LIST SHALL NOT BE CONSTRUED AS AN OFFER TO SELL TO THE BEARER.

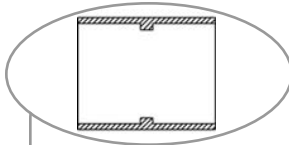

**Coupling**

Size	Part #	Price
<b>Flame Retardant</b>		
8"	131108001	\$350.00
10"	131710001	\$540.30
12"	131712001	\$600.30

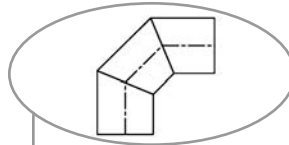

**90° Elbow**

Size	Part #	Price
<b>Flame Retardant</b>		
8"	01108003	\$1,010.70
10"	01110003	\$1,089.30
12"	01112003	\$1,339.40
<b>Non-Flame Retardant</b>		
8"	01308003	\$934.90
10"	01310003	\$986.30
12"	01312003	\$1,165.10

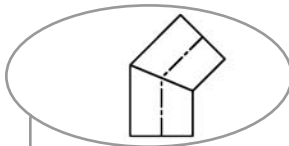

**45° Elbow**

Size	Part #	Price
<b>Flame Retardant</b>		
8"	01108002	\$721.20
10"	01110002	\$742.30
12"	01112002	\$750.90
<b>Non-Flame Retardant</b>		
8"	01308002	\$640.80
10"	01310002	\$647.10
12"	01312002	\$654.10

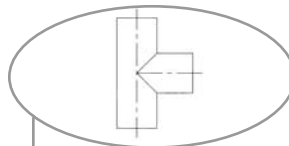

**Tee**

Size	Part #	Price
<b>Flame Retardant</b>		
8"	01108005	\$1,068.70
10"	01110005	\$2,746.50
12"	01112005	\$3,051.50
<b>Non-Flame Retardant</b>		
8"	01308005	\$988.00
10"	01310005	\$2,746.50
12"	01312005	\$3,051.50

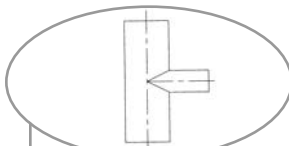

**Reducing Tee**

Size	Part #	Price
<b>Flame Retardant</b>		
8" x 4"	011080406	\$446.50
8" x 6"	011080606	\$675.50
10" x 4"	011100406	\$1,848.50
10" x 6"	011100606	\$1,979.30
10" x 8"	011100806	\$2,218.20
<b>Non-Flame Retardant</b>		
8" x 4"	013080406	\$426.60
8" x 6"	013080606	\$516.10
10" x 4"	013100406	\$1,712.10
10" x 6"	013100606	\$1,740.50
10" x 8"	013100806	\$1,938.00

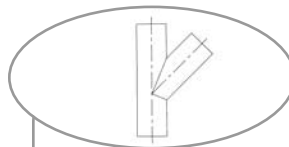

**Wye**

Size	Part #	Price
<b>Flame Retardant</b>		
8"	01108008	\$1,813.00
10"	01110008	\$1,958.00
12"	01112008	\$2,346.20
<b>Non-Flame Retardant</b>		
8"	01308008	\$1,685.10
10"	01310008	\$1,791.60
12"	01312008	\$2,132.80

**Note: All 8" and larger pipe and fittings are non-concealable and non-returnable. F.O.B. Kansas City, Kansas. NO FREIGHT ALLOWANCE.**

**Note: All Fittings Are Sold As Plain End. Couplings Must Be Purchased Separately.**

Prices Subject to change without notice, Possession of this price list shall not be construed as an offer to sell to the bearer.

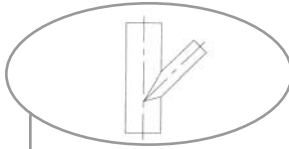

**Reducing Wye**

Size	Part #	Price
<b>Flame Retardant</b>		
8" x 4"	011080409	\$844.70
8" x 6"	011080609	\$1,282.60
10" x 4"	011100409	\$1,909.60
10" x 6"	011100609	\$1,923.80
10" x 8"	011100809	\$1,950.00
12" x 8"	011120809	\$2,644.60
12" x 10"	011121009	\$2,698.20
<b>Non-Flame Retardant</b>		
8" x 4"	013080409	\$796.30
8" x 6"	013080609	\$1,185.80
10" x 4"	013100409	\$1,686.50
10" x 6"	013100609	\$1,712.10
10" x 8"	013100809	\$1,777.40
12" x 8"	013120809	\$2,097.40
12" x 10"	013121009	\$2,168.50

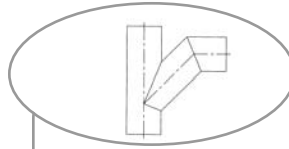

**Combo Wye + 1/8" Bend**

Size	Part #	Price
<b>Flame Retardant</b>		
8"	01108010	\$1,901.40
10"	01110010	\$2,867.30
12"	01112010	\$3,750.00
<b>Non-Flame Retardant</b>		
8"	01308010	\$1,760.80
10"	01310010	\$2,061.40
12"	01312010	\$3,500.00

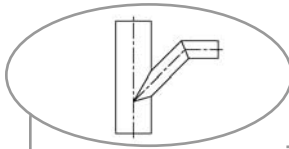

**Reducing Combo Wye + 1/8" Bend**

Size	Part #	Price
<b>Flame Retardant</b>		
8" x 4"	011080411	\$1,342.40
8" x 6"	011080611	\$1,376.80
10" x 4"	011100411	\$2,053.20
10" x 6"	011100611	\$2,204.00
10" x 8"	011100811	\$2,245.20
12" x 8"	011120811	\$2,633.40
12" x 10"	011121011	\$3,707.00
<b>Non-Flame Retardant</b>		
8" x 4"	013080411	\$1,108.50
8" x 6"	013080611	\$1,247.10
10" x 4"	013100411	\$1,854.90
10" x 6"	013100611	\$1,955.20
10" x 8"	013100811	\$2,020.60
12" x 8"	013120811	\$2,291.50
12" x 10"	013121011	\$3,223.60

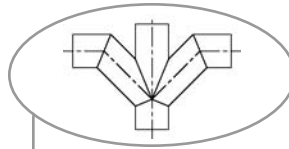

**Double Combo Wye + 1/8" Bend**

Size	Part #	Price
<b>Flame Retardant</b>		
8"	01108013	\$2,376.80
10"	01110013	\$3,584.10
12"	01112013	\$4,582.60
<b>Non-Flame Retardant</b>		
8"	01308013	\$2,201.00
10"	01310013	\$2,576.80
12"	01312013	\$3,984.90

**Note: All 8" and larger pipe and fittings are non-concealable and non-returnable. F.O.B. Kansas City, Kansas. NO FREIGHT ALLOWANCE.**

**Note: All Fittings Are Sold As Plain End. Couplings Must Be Purchased Separately.**

Prices Subject to change without notice, Possession of this price list shall not be construed as an offer to sell to the bearer.

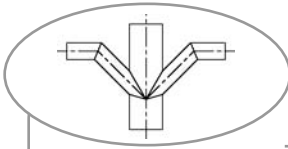

**Double Reducing  
Combo Wye +1/8" Bend**

Size	Part #	Price
<b>Flame Retardant</b>		
8" x 4"	011080416	\$929.20
8" x 6"	011080616	\$1,410.90
10" x 4"	011100416	\$2,100.60
10" x 6"	011100616	\$2,116.20
10" x 8"	011100816	\$2,117.30
12" x 8"	011120816	\$3,832.10
12" x 10"	011121016	\$4,265.70
<b>Non-Flame Retardant</b>		
8" x 4"	013080416	\$875.90
8" x 6"	013080616	\$1,304.40
10" x 4"	013100416	\$1,855.20
10" x 6"	013100616	\$1,883.30
10" x 8"	013100816	\$1,955.10
12" x 8"	013120816	\$3,331.50
12" x 10"	013121016	\$3,708.40

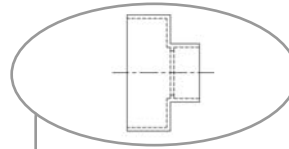

**Reducer**

Size	Part #	Price
<b>Flame Retardant</b>		
8" x 4"	011080451	\$717.00
8" x 6"	011080651	\$793.20
10" x 4"	011100451	\$1,126.00
10" x 6"	011100651	\$1,170.20
10" x 8"	011100851	\$1,207.30
<b>Non-Flame Retardant</b>		
8" x 4"	013080451	\$663.60
8" x 6"	013080651	\$738.50
10" x 4"	013100451	\$1,018.00
10" x 6"	013100651	\$1,025.50
10" x 8"	013100851	\$1,049.40
12" x 10"	013121051	\$1,250.00

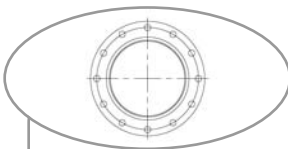

**Flange**

Size	Part #	Price
<b>Flame Retardant</b>		
8"	01108035	\$753.40
10"	01110035	\$982.50
12"	01120035	\$1,589.20
<b>Non-Flame Retardant</b>		
8"	01308035	\$722.10
10"	01310035	\$907.00
12"	01312035	\$1,478.50

**Note: All 8" and larger pipe and fittings are non-concealable and non-returnable. F.O.B. Kansas City, Kansas. NO FREIGHT ALLOWANCE.**

**Note: All Fittings Are Sold As Plain End. Couplings Must Be Purchased Separately.**

Prices Subject to change without notice, Possession of this price list shall not be construed as an offer to sell to the bearer.

# Socket Fusion Polypropylene Acid Waste Drainage

*Blueline fire retardant Proxylene and Brownline polypropylene pipe*  
 All pipe is supplied in 10 foot grooved lengths.  
 Prices per 100 feet.  
 Pipe is non-cancelable and non-returnable

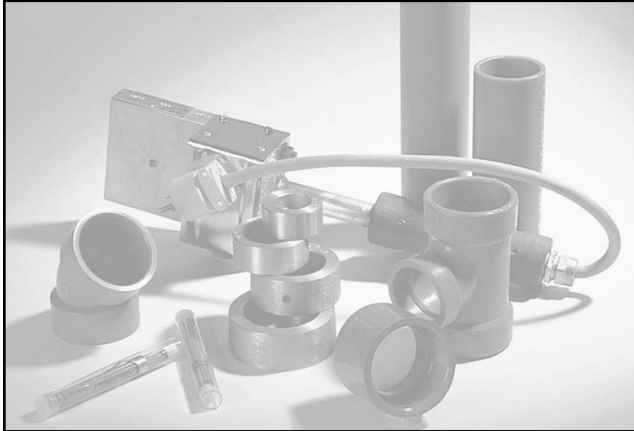



PIPE					
Size	Part#	Price	Size	Part#	Price
<b>BLUELINE SCHEDULE 40</b>			<b>BLUELINE SCHEDULE 80</b>		
1-1/2"	0110156440	\$1,176.00	1-1/2"	0110156480	\$1,671.00
2"	0110206440	\$1,614.00	2"	0110206480	\$2,079.00
3"	0110306440	\$2,922.00	3"	0110306480	\$3,961.00
4"	0110406440	\$4,146.00	4"	0110406480	\$5,186.00
6"	0110606440	\$7,016.00	6"	0110606480	\$11,001.00
<b>BROWNLIN SCHEDULE 40</b>			<b>BROWNLIN SCHEDULE 80</b>		
1-1/2"	0120156440	\$759.00	1-1/2"	0120156480	\$1,207.00
2"	0120206440	\$1,026.00	2"	0120206480	\$1,571.00
3"	0120306440	\$2,106.00	3"	0120306480	\$2,890.00
4"	0120406440	\$2,680.00	4"	0120406480	\$4,049.00
6"	0120606440	\$5,368.00	6"	0120606480	\$7,774.00

Pipe Cut Charge	
1 1/2" - 6"-\$5.00/Cut	8" & Larger -\$10.00/Cut

COUPLING - CLS			
	Size	Part#	Price
	1-1/2"	31101501	\$17.30
	2"	31102001	\$22.30
	3"	31103001	\$36.40
	4"	31104001	\$48.90
	6"	31106001	\$83.80

45° ELBOW - 1/8 BEND			
	Size	Part#	Price
	1-1/2"	31101502	\$32.70
	2"	31102002	\$33.70
	3"	31103002	\$61.70
	4"	31104002	\$78.00
	6"	31106002	\$189.90

SINGLE SOCKET 45° ELBOW - 1/8 BEND			
	Size	Part#	Price
	1-1/2"	31101548	\$32.70
	2"	31102048	\$33.70
	3"	31103048	\$61.70
	4"	31104048	\$78.00
	6"	31106048	\$189.90

90° ELBOW - 1/4 BEND			
	Size	Part#	Price
	1-1/2"	31101503	\$34.50
	2"	31102003	\$38.20
	3"	31103003	\$65.50
	4"	31104003	\$101.10
	6"	31106003	\$232.90

Attention: Do not pressure test with compressed air or gas! Severe damage or bodily injury can result.  
 PRICES SUBJECT TO CHANGE WITHOUT NOTICE, POSSESSION OF THIS PRICE LIST SHALL NOT BE CONSTRUED AS AN OFFER TO SELL TO THE BEARER.

**SINGLE SOCKET 90° ELBOW - 1/4 BEND**

	Size	Part#	Price
	1-1/2"	31101549	\$34.50
	2"	31102049	\$38.20
	3"	31103049	\$65.50
	4"	31104049	\$101.10
	6"	31106049	\$232.90

**REDUCING SANITARY TEE - R90T**

	Size	Part#	Price
	2" x 1-1/2"	311021506	\$61.00
	3" x 1-1/2"	311031506	\$89.90
	3" x 2"	311030206	\$94.70
	4" x 1-1/2"	311041506	\$157.40
	4" x 2"	311040206	\$159.50
	4" x 3"	311040306	\$164.30

Double reducing sanitary tee available-contact Orion

**SANITARY TEE - 90T**

	Size	Part#	Price
	1-1/2"	31101505	\$42.20
	2"	31102005	\$47.80
	3"	31103005	\$89.40
	4"	31104005	\$137.30

Double sanitary tee available-contact Orion

**REDUCING WYE - R45Y**

	Size	Part#	Price
	2" x 1-1/2"	311021509	\$55.40
	3" x 1-1/2"	311031509	\$84.40
	3" x 2"	311030209	\$89.40
	4" x 1-1/2"	311041509	\$149.60
	4" x 2"	311040209	\$167.00
	4" x 3"	311040309	\$199.00
	*6" x 2"	311060209	\$326.10
	*6" x 3"	311060309	\$330.00
	*6" x 4"	311060409	\$339.20

**CLEANOUT TEE - WITH PLUG COT**

	Size	Part#	Price
	1-1/2"	31101507	\$83.30
	2"	31102007	\$89.70
	3"	31103007	\$176.40
	4"	31104007	\$235.60
	6"	31106007	\$760.80

**REDUCING LONG TURN TEE WYE - RLTY  
(Reducing Combo wye + 1/8 bend)**

	Size	Part#	Price
	2" x 1-1/2"	311021511	\$85.30
	3" x 1-1/2"	311031511	\$103.60
	3" x 2"	311030211	\$116.50
	4" x 1-1/2"	311041511	\$154.00
	4" x 2"	311040211	\$156.60
	4" x 3"	311040311	\$166.70
	*6" x 2"	311060211	\$341.10
	*6" x 3"	311060311	\$346.10
	*6" x 4"	311060411	\$348.60

**45° WYE**

	Size	Part#	Price
	1-1/2"	31101508	\$58.90
	2"	31102008	\$74.30
	3"	31103008	\$94.60
	4"	31104008	\$141.20
	6"	31106008	\$342.30

**LONG TURN TEE WYE - LTY  
(Combo wye + 1/8 bend)**

	Size	Part#	Price
	1-1/2"	31101510	\$109.20
	2"	31102010	\$127.30
	3"	31103010	\$175.40
	4"	31104010	\$237.30
	*6"	31106010	\$445.80

\* Non-Cancelable, Non-Returnable

Attention: Do not pressure test with compressed air or gas! Severe damage or bodily injury can result.

PRICES SUBJECT TO CHANGE WITHOUT NOTICE, POSSESSION OF THIS PRICE LIST SHALL NOT BE CONSTRUED AS AN OFFER TO SELL TO THE BEARER.

<b>UPRIGHT WYE - UTY</b>			
	Size	Part#	Price
	*1-1/2"	31101512	\$53.30
	*2"	31102012	\$73.80
	*3"	31103012	\$109.30
	*4"	31104012	\$262.90
	*6"	31106012	\$439.40

<b>DOUBLE WYE - D45Y</b>			
	Size	Part#	Price
	1-1/2"	31101513	\$65.50
	2"	31102013	\$102.10
	3"	31103013	\$158.80
	4"	31104013	\$326.40
	*6"	31106013	\$710.60

<b>REDUCING DOUBLE WYE - RD45Y</b>			
	Size	Part#	Price
	2" x 1-1/2"	311021514	\$103.20
	3" x 1-1/2"	311031514	\$155.40
	3" x 2"	311030214	\$158.70
	4" x 1-1/2"	311041514	\$283.30
	4" x 2"	311040214	\$290.20
	4" x 3"	311040314	\$295.30
	*6" x 2"	311060214	\$707.90
	*6" x 3"	311060614	\$719.30
*6" x 4"	311060414	\$734.40	

<b>DOUBLE LONG TURN TEE WYE - DLTW</b>			
	Size	Part#	Price
	1-1/2"	31101515	\$78.30
	2"	31102015	\$119.90
	3"	31103015	\$174.20
	4"	31104015	\$475.40
	*6"	31106015	\$1,042.90

<b>DOUBLE REDUCING LONG TURN TEE WYE - RDLTW</b>			
	Size	Part#	Price
	2" x 1-1/2"	311021516	\$124.60
	3" x 1-1/2"	311031516	\$170.30
	3" x 2"	311030216	\$178.50
	4" x 1-1/2"	311041516	\$284.00
	4" x 2"	311040216	\$286.90
	4" x 3"	311040316	\$291.00
	*6" x 2"	311060216	\$708.20
	*6" x 3"	311060616	\$716.00
*6" x 4"	311060416	\$726.00	

<b>MALE ADAPTER - MA</b>			
	Size	Part#	Price
	1-1/2"	31101517	\$25.00
	2"	31102017	\$31.50
	3"	31103017	\$39.60
	4"	31104017	\$76.10
	6"	31106017	\$206.20

Reducing male adapters available. Contact Orion.

<b>FEMALE ADAPTER - FA</b>			
	Size	Part#	Price
	1-1/2"	31101518	\$25.30
	2"	31102018	\$31.80
	3"	31103018	\$39.50
	4"	31104018	\$76.10
	6"	31106018	\$206.20

Reducing Female adapters available. Contact Orion.

<b>CLEANOUT ADAPTER W/PLUG COA</b>			
	Size	Part#	Price
	1-1/2"	31101519	\$37.50
	2"	31102019	\$51.10
	3"	31103019	\$84.20
	4"	31104019	\$138.10
	6"	31106019	\$336.10

\* Non-Cancelable, Non-Returnable

Attention: Do not pressure test with compressed air or gas! Severe damage or bodily injury can result.

PRICES SUBJECT TO CHANGE WITHOUT NOTICE, POSSESSION OF THIS PRICE LIST SHALL NOT BE CONSTRUED AS AN OFFER TO SELL TO THE BEARER.

**CAP**

	Size	Part#	Price
	1-1/2"	31101521	\$21.80
	2"	31102021	\$28.10
	3"	31103021	\$36.20
	4"	31104021	\$67.30
	6"	31106021	\$113.20

**REDUCING BUSHING - RB**

	Size	Part#	Price
	2" x 1-1/2"	311021522	\$25.40
	3" x 1-1/2"	311031522	\$39.20
	3" x 2"	311030222	\$41.40
	4" x 1-1/2"	311041522	\$60.90
	4" x 2"	311040222	\$61.50
	4" x 3"	311040322	\$63.40
	6" x 2"	311060222	\$130.10
	6" x 3"	311060322	\$136.10
	6" x 4"	311060422	\$143.70

**REDUCING COUPLING - RCLS**

	Size	Part#	Price
	2" x 1-1/2"	311021551	\$25.50
	3" x 1-1/2"	311031551	\$51.00
	3" x 2"	311030251	\$54.10
	4" x 1-1/2"	311041551	\$85.20
	4" x 2"	311040251	\$88.20
	4" x 3"	311040351	\$95.20
	6" x 2"	311060251	\$114.70
	6" x 3"	311060351	\$118.80
6" x 4"	311060451	\$123.40	

**P TRAP - UTP**

	Size	Part#	Price
	1-1/2"	31101525	\$123.30
	2"	31102025	\$175.50

**RUNNING TRAP - UTR**

	Size	Part#	Price
	1-1/2"	31101526	\$127.90
	2"	31102026	\$180.90

**S TRAP - UTP-S**

	Size	Part#	Price
	*1-1/2"	31101527	\$170.60
	*2"	31102027	\$226.50

**P TRAP - RBP**

	Size	Part#	Price
	*1-1/2"	31101528	\$57.20
	*2"	31102028	\$71.10
	*3"	31103028	\$211.20
	*4"	31104028	\$287.30
	*6"	31106028	\$571.50

**S TRAP - RBP-S**

	Size	Part#	Price
	*1-1/2"	31101529	\$95.10
	*2"	31102029	\$117.60
	*3"	31103029	\$192.80
	*4"	31104029	\$308.50

\* Non-Cancelable, Non-Returnable

Attention: Do not pressure test with compressed air or gas! Severe damage or bodily injury can result.

PRICES SUBJECT TO CHANGE WITHOUT NOTICE, POSSESSION OF THIS PRICE LIST SHALL NOT BE CONSTRUED AS AN OFFER TO SELL TO THE BEARER.

<b>RLNS</b>			
	Size	Part#	Price
	1-1/2"	31101530	\$30.50
	2"	31102030	\$45.50

<b>SINK TAIL PIECE EXTENSION-RLNSx12</b>			
	Size	Part#	Price
	1-1/2" RLNS x 12"	01101531	\$77.40
	2" RLNS x 12"	01102031	\$88.20

<b>SLIP JOINT ADAPTER - SJ</b>			
	Size	Part#	Price
	1-1/2"	31101532	\$57.20
	2"	31102032	\$68.20

<b>SLIP JOINT ADAPTER EXTENSION - SJAx12</b>			
	Size	Part#	Price
	1-1/2"	01101533	\$81.60
	2"	01102033	\$89.70

<b>SWIVEL DRUM TRAP - DT-1</b>			
	Size	Part#	Price
	1-1/2"	31101538	\$224.60
	2"	31102038	\$229.70

<b>FLANGE</b>			
	Size	Part#	Price
	1-1/2"	31101535	\$112.70
	2"	31102035	\$123.30
	3"	31103035	\$162.40
	4"	31104035	\$192.80
	6"	31106035	\$264.70

Blind flange available.  
Please contact Orion.

<b>BACKING RING</b>			
	Size	Part#	Price
	1-1/2"	04001536	\$63.80
	2"	04002036	\$70.60
	3"	04003036	\$93.00
	4"	04004036	\$111.70
	6"	04006036	\$122.60

<b>BOTTLE TRAPS</b>			
	Size	Part#	Price
	*BT-1	31101537	\$73.40
	BT-2	31101581	\$101.60
	*BT-3	31101582	\$139.60
<b>BOTTLES ONLY</b>			
	1 Pt	01450076	\$58.40
	1 Qt	01451076	\$63.60
	2 Qt	01452076	\$71.10
<b>*Bottle not included</b>			

Attention: Do not pressure test with compressed air or gas! Severe damage or bodily injury can result.  
 PRICES SUBJECT TO CHANGE WITHOUT NOTICE. POSSESSION OF THIS PRICE LIST SHALL NOT BE CONSTRUED AS AN  
 OFFER TO SELL TO THE BEARER.

**FLOOR DRAIN - AWFSTD**

Size	Part#	Price
2"	31102045	\$577.30
3"	31103045	\$594.90
4"	31104045	\$636.10
*6"	31106045	\$854.30

**SIDE OUTLET FLOOR DRAIN - AWFDSO**

Size	Part#	Price
*2"	31102046	\$779.80
*3"	31103046	\$792.50
*4"	31104046	\$795.30

**INTEGRAL TRAP FLOOR DRAIN - AWFDP**

Size	Part#	Price
*2"	31102047	\$765.40
*3"	31103047	\$886.70
*4"	31104047	\$995.00

**ACID WASTE CLEANOUTS\***

With adjustable  
top for finished  
floors

Size	Part#	Price
<u>Brushed Bronze Square</u>		
3"	01103044SBB	\$544.60
4"	01104044SBB	\$587.30
<u>Nickle Bronze Square</u>		
3"	01103044SNB	\$544.60
4"	01104044SNB	\$587.30
<u>Brushed Bronze Round</u>		
3"	01103044RBB	\$544.60
4"	01104044RBB	\$587.30
<u>Nickle Bronze Round</u>		
3"	01103044RNB	\$544.60
4"	01104044RNB	\$587.30

**FLOOR DRAIN ACCESSORIES**

*Funnel-4"x9"	01300065	\$94.70
*1/2" Trap primer connection FIP	01000066	\$64.10
*Sediment bucket	01300067	\$96.30
*Flashing clamp	04000068	\$74.70
*Vandal proofing	000000VP	\$108.90
*Solid cover	01300069	\$121.60

\* Non-Cancelable, Non-Returnable

Attention: Do not pressure test with compressed air or gas! Severe damage or bodily injury can result.

PRICES SUBJECT TO CHANGE WITHOUT NOTICE, POSSESSION OF THIS PRICE LIST SHALL NOT BE CONSTRUED AS AN OFFER TO SELL TO THE BEARER.

# PVDF - NO HUB/PLAIN END Acid Waste Drainage

All pipe is supplied in 10 foot grooved lengths.

Pipe prices per 100 feet.

**PVDF Pipe and fittings are non-cancelable and non-returnable.**

**NOTE: All material is dark blue color.**

PIPE*		
Size	Part#	Price
<b>SUPER BLUE SCHEDULE 40</b>		
1-1/2"	0210156440	\$3,573.00
2"	0210206440	\$5,244.00
3"	0210306440	\$9,891.00
4"	0210406440	\$16,644.00
6"	0210606440	\$38,320.00

RIONFUSE CF COUPLING			
Size	Part#	Price	
1-1/2"	132101501	\$31.80	
2"	132102001	\$40.30	
3"	132103001	\$84.30	
4"	132104001	\$103.80	
6"	132106001	\$161.70	



NO HUB COUPLING			
Size	Part#	Price	
1-1/2"	12101501	\$19.90	
2"	12102001	\$21.70	
3"	12103001	\$26.40	
4"	12104001	\$34.20	
6"	12106001	\$75.90	



45° ELBOW - 1/8 bend			
Size	Part#	Price	
1-1/2"	02101502	\$22.20	
2"	02102002	\$25.80	
3"	02103002	\$155.40	
4"	02104002	\$264.00	
6"	02106002	\$585.90	



90° ELBOW-1/4 Bend			
Size	Part#	Price	
1-1/2"	02101503	\$49.20	
2"	02102003	\$70.80	
3"	02103003	\$171.80	
4"	02104003	\$334.40	
6"	02106003	\$686.20	

LONG SWEEP 90° ELBOWS:			
Size	Part#	Price	
1-1/2"	02101504	\$83.70	
2"	02102004	\$94.20	
3"	02103004	\$263.00	
4"	02104004	\$458.10	

SANITARY TEE - 90T			
Size	Part#	Price	
1-1/2"	02101505	\$70.50	
2"	02102005	\$150.80	
3"	02103005	\$296.40	
4"	02104005	\$498.70	



Note: for 6" tee use Long turn Tee-Wye

REDUCING SANITARY TEE - R90T			
Size	Part#	Price	
2" x 1-1/2"	021021506	\$90.50	
3" x 1-1/2"	021031506	\$162.30	
3" x 2"	021030206	\$201.70	
4" x 1-1/2"	021041506	\$870.80	
4" x 2"	021040206	\$879.30	
4" x 3"	021040306	\$897.40	



Note: for 6" red tees use Long turn Tee-Wye

DOUBLE SANITARY TEE - 90T			
Size	Part#	Price	
1-1/2"	02101579	\$341.20	
2"	02102079	\$376.10	
3"	02103079	\$698.50	
4"	02104079	\$970.20	

CLEAN-OUT TEE - COT W/PLUG			
Size	Part#	Price	
1-1/2"	02101507	\$129.60	
2"	02102007	\$185.10	
3"	02103007	\$359.00	
4"	02104007	\$601.20	
6"	02106007	POA	





**Note: All Fittings Are Sold As Plain End. Couplings Must Be Purchased Separately.**

Attention: Do not pressure test with compressed air or gas! Severe damage or bodily injury can result.

PRICES SUBJECT TO CHANGE WITHOUT NOTICE, POSSESSION OF THIS PRICE LIST SHALL NOT BE CONSTRUED AS AN OFFER TO SELL TO THE BEARER.

SINGLE WYE - 45Y			
	Size	Part#	Price
	1-1/2"	02101508	\$77.20
	2"	02102008	\$132.60
	3"	02103008	\$257.70
	4"	02104008	\$431.50
	6"	02106008	\$869.70

REDUCING WYE - R45Y			
	Size	Part#	Price
	2 x 1-1/2"	021021509	\$87.70
	3 x 1-1/2"	021031509	\$194.20
	3 x 2"	021030209	\$198.40
	4 x 1-1/2"	021041509	\$367.60
	4 x 2"	021040209	\$388.10
	4 x 3"	021040309	\$405.10
	6 x 2"	021060209	\$1,115.30
	6 x 3"	021060309	\$1,138.40
	6 x 4"	021060409	\$1,167.40

LONG TURN TEE WYE - LTY (Combo wye +1/8 bend)			
	Size	Part#	Price
	1-1/2"	02101510	\$132.30
	2"	02102010	\$192.10
	3"	02103010	\$448.80
	4"	02104010	\$714.40
	6"	02106010	\$1,582.50

LONG TURN TEE WYE REDUCING - RLTY (Reducing Combo wye +1/8 bend)			
	Size	Part#	Price
	2" x 1-1/2"	021021511	\$165.20
	3" x 1-1/2"	021031511	\$238.90
	3" x 2"	021030211	\$255.30
	4" x 1-1/2"	021041511	\$413.70
	4" x 2"	021040211	\$434.20
	4" x 3"	021040311	\$515.20
	6" x 2"	021060211	\$1,335.80
	6" x 3"	021060311	\$1,360.40
	6" x 4"	021060411	\$1,464.40

DOUBLE WYE - D45Y			
	Size	Part#	Price
	1-1/2"	02101513	\$204.30
	2"	02102013	\$322.90
	3"	02103013	\$419.10
	4"	02104013	\$537.60
	6"	02106013	\$1,055.10

REDUCING DOUBLE WYE - RD45Y			
	Size	Part#	Price
	2" x 1-1/2"	021021514	\$342.50
	3" x 1-1/2"	021031514	\$451.20
	3" x 2"	021030214	\$458.40
	4" x 1-1/2"	021041514	\$921.70
	4" x 2"	021040214	\$924.20
	4" x 3"	021040314	\$993.30
	6" x 2"	021060214	\$1,926.40
	6" x 3"	021060314	\$1,995.20
	6" x 4"	021060414	\$2,012.60

DOUBLE LONG TURN TEE WYE - DLTY (Double Combo wye +1/8 bend)			
	Size	Part#	Price
	1-1/2"	02101515	\$288.90
	2"	02102015	\$363.40
	3"	02103015	\$793.80
	4"	02104015	\$1,226.90
	6"	02106015	\$2,494.80

DOUBLE REDUCING LONG TURN TEE WYE - RDLTY (Double Reducing Combo wye +1/8 bend)			
	Size	Part#	Price
	2" x 1-1/2"	021021516	\$453.80
	3" x 1-1/2"	021031516	\$568.90
	3" x 2"	021030216	\$607.70
	4" x 1-1/2"	021041516	\$962.90
	4" x 2"	021040216	\$992.00
	4" x 3"	021040316	\$1,120.60
	6" x 2"	021060216	\$1,890.70
	6" x 3"	021060316	\$2,438.90
	6" x 4"	021060416	\$2,647.50

**Note: All Fittings Are Sold As Plain End. Couplings Must Be Purchased Separately.**

Attention: Do not pressure test with compressed air or gas! Severe damage or bodily injury can result.  
 PRICES SUBJECT TO CHANGE WITHOUT NOTICE, POSSESSION OF THIS PRICE LIST SHALL NOT BE CONSTRUED AS AN  
 OFFER TO SELL TO THE BEARER.

<b>MALE ADAPTER - MA</b>			
	Size	Part#	Price
	1-1/2"	02101517	\$31.50
	2"	02102017	\$41.60
	3"	02103017	\$81.60
	4"	02104017	\$109.70
	6"	02106017	\$283.80
Reducing Male adapters available. Contact Orion.			

<b>FEMALE ADAPTER - FA</b>			
	Size	Part#	Price
	1-1/2"	02101518	\$31.50
	2"	02102018	\$41.60
	3"	02103018	\$81.60
	4"	02104018	\$109.70
	6"	02106018	\$283.80
Reducing Female adapters available. Contact Orion.			

<b>CLEANOUT ADAPTER W/PLUG - COA</b>			
	Size	Part#	Price
	1-1/2"	02101519	\$70.10
	2"	02102019	\$89.20
	3"	02103019	\$186.60
	4"	02104019	\$262.50
	6"	02106019	\$650.40

<b>CLEANOUT PLUG - CPC</b>			
	Size	Part#	Price
	1-1/2"	02101520	\$38.70
	2"	02102020	\$47.60
	3"	02103020	\$105.00
	4"	02104020	\$152.70
	6"	02106020	\$366.60
Counter sunk plug available at same price. Add "CSK" at end of part#			

<b>CAP</b>			
	Size	Part#	Price
	1-1/2"	02101521	\$76.20
	2"	02102021	\$90.60
	3"	02103021	\$143.00
	4"	02104021	\$174.70
	6"	02106021	\$280.80

<b>REDUCING BUSHING - RB</b>			
	Size	Part#	Price
	2" x 1-1/2"	021021522	\$50.50
	3" x 1-1/2"	021031522	\$71.60
	3" x 2"	021030222	\$84.70
	4" x 1-1/2"	021041522	\$123.90
	4" x 2"	021040222	\$129.10
	4" x 3"	021040322	\$140.70
	6" x 2"	021060222	\$297.20
	6" x 3"	021060322	\$343.60
	6" x 4"	021060422	\$395.40

<b>P TRAP - UTP</b>			
	Size	Part#	Price
	1-1/2"	02101525	\$287.50
	2"	02102025	\$410.30

<b>RUNNING TRAP - UTR</b>			
	Size	Part#	Price
	1-1/2"	02101526	\$350.20
	2"	02102026	\$499.50

**Note: All Fittings Are Sold As Plain End. Couplings Must Be Purchased Separately.**

Attention: Do not pressure test with compressed air or gas! Severe damage or bodily injury can result.  
 PRICES SUBJECT TO CHANGE WITHOUT NOTICE, POSSESSION OF THIS PRICE LIST SHALL NOT BE CONSTRUED AS AN OFFER TO SELL TO THE BEARER.

**P TRAP - RBP**

Size	Part#	Price
*1-1/2"	02101528	\$184.70
*2"	02102028	\$255.90
3"	02103028	\$651.00
4"	02104028	\$1,266.40
*6"	02106028	\$4,863.20

**RLNS**

Size	Part#	Price
1-1/2"	02101530	\$66.40
2"	02102030	\$107.20

**SINK TAIL PIECE EXTENSION RLNS X 12"**

Size	Part#	Price
1-1/2"	02101531	\$124.20
2"	02102031	\$177.40

**FLANGE - FLG**

Size	Part#	Price
1-1/2"	02101535	\$116.70
2"	02102035	\$188.20
3"	02103035	\$298.40
4"	02104035	\$350.30
6"	02106035	\$446.60



Blind flanges available  
Contact Orion.

**BACKING RING**

Size	Part#	Price
1-1/2"	04001536	\$63.80
2"	04002036	\$70.60
3"	04003036	\$93.00
4"	04004036	\$111.70
6"	04006036	\$122.60

**ACID WASTE FLOOR CLEAN-OUTS\***

Size	Part#	Price
<u>Brushed Bronze Square</u>		
3"	02103044SBB	\$579.00
4"	02104044SBB	\$621.00
<u>Nickle Bronze Square</u>		
3"	02103044SNB	\$579.00
4"	02104044SNB	\$621.00
<u>Brushed Bronze Round</u>		
3"	02103044RBB	\$579.00
4"	02104044RBB	\$621.00
<u>Nickle Bronze Round</u>		
3"	02103044RNB	\$579.00
4"	02104044RNB	\$621.00

**FLOOR DRAIN - FD-1 (AWFDSTD)**

Size	Part#	Price
2" MJ	02102045	\$560.90
3" MJ	02103045	\$638.20
4" MJ	02104045	\$708.30
6" MJ	02106045	\$856.70



Side outlet and Drain with P-Trap also available

**DRUM TRAP-DT -1**

Size	Part#	Price
1-1/2"	02102038	\$666.80
2"	02103038	\$727.80

**FLOOR DRAIN ACCESSORIES**

Funnel - 4"x9"	02300065	\$94.70
1/2" trap primer connection FIP	02000066	\$64.10
Sediment bucket	01300067	\$96.30
Flashing clamp	04000068	\$74.70
Vandal proofing	000000VP	\$108.90
Solid cover	02300069	\$121.60

**Note: All Fittings Are Sold As Plain End. Couplings Must Be Purchased Separately.**

\* Non-Cancelable, Non-Returnable

Attention: Do not pressure test with compressed air or gas! Severe damage or bodily injury can result.

PRICES SUBJECT TO CHANGE WITHOUT NOTICE, POSSESSION OF THIS PRICE LIST SHALL NOT BE CONSTRUED AS AN OFFER TO SELL TO THE BEARER.

# PVDF Socket Fusion Acid Waste Drainage

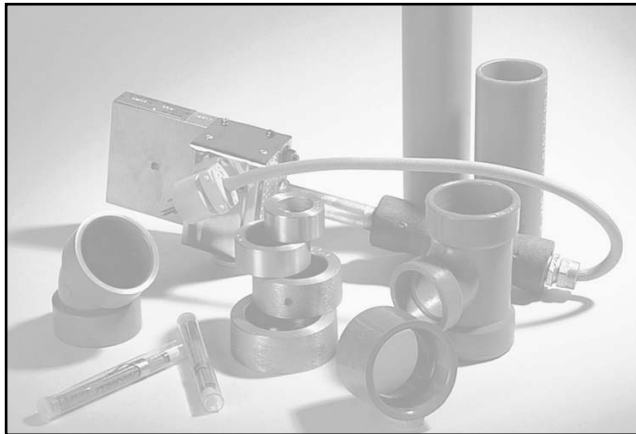

All pipe is supplied in 10 foot grooved lengths.  
Prices per 100 feet.

Pipe and fittings are non-cancelable and non-returnable.

**NOTE: All material is dark blue color.**

<b>Pipe Cut Charge</b>	
<b>1½" - 6"-\$5.00/Cut</b>	<b>8" &amp; Larger -\$10.00/Cut</b>

<b>PIPE*</b>		
Size	Part#	Price
<b>SUPER BLUE SCHEDULE 40</b>		
1-1/2"	0210156440	\$3,573.00
2"	0210206440	\$5,244.00
3"	0210306440	\$9,891.00
4"	0210406440	\$16,644.00
6"	0210606440	\$38,320.00

<b>COUPLING - CLS</b>			
	Size	Part#	Price
	1-1/2"	32101501	\$33.50
	2"	32102001	\$42.00
	3"	32103001	\$76.60
	4"	32104001	\$122.60
	6"	32106001	\$371.10

<b>45° ELBOW SINGLE SOCKET - 1/8 Bend</b>			
	Size	Part#	Price
	1-1/2"	32101548	\$43.20
	2"	32102048	\$48.40
	3"	32103048	\$178.40
	4"	32104048	\$303.10
	6"	32106048	\$684.00

<b>45° ELBOW - 1/8 Bend</b>			
	Size	Part#	Price
	1-1/2"	32101502	\$42.20
	2"	32102002	\$48.40
	3"	32103002	\$178.40
	4"	32104002	\$303.10
	6"	32106002	\$684.00

<b>90° ELBOW SINGLE SOCKET - 1/4 Bend</b>			
	Size	Part#	Price
	1-1/2"	32101549	\$51.20
	2"	32102049	\$70.70
	3"	32103049	\$199.60
	4"	32104049	\$387.50
	6"	32106049	\$1,338.50

<b>90° ELBOW - 1/4 Bend</b>			
	Size	Part#	Price
	1-1/2"	32101503	\$51.20
	2"	32102003	\$70.70
	3"	32103003	\$199.60
	4"	32104003	\$387.50
	6"	32106003	\$1,338.50

\* Non-Cancelable, Non-Returnable

Attention: Do not pressure test with compressed air or gas! Severe damage or bodily injury can result.

PRICES SUBJECT TO CHANGE WITHOUT NOTICE, POSSESSION OF THIS PRICE LIST SHALL NOT BE CONSTRUED AS AN OFFER TO SELL TO THE BEARER.

**SANITARY TEE - 90T**

Size	Part#	Price
1-1/2"	32101505	\$69.10
2"	32102005	\$119.20
3"	32103005	\$275.70
4"	32104005	\$465.50

**REDUCING TEE - 90T**

Size	Part#	Price
2" x 1-1/2"	321021506	\$119.20
3" x 1-1/2"	321031506	\$207.80
3" x 2"	321030206	\$235.00
4" x 1-1/2"	321041506	\$918.40
4" x 2"	321040206	\$930.50
4" x 3"	321040306	\$942.70

**CLEANOUT TEE - COT W/PLUG**

Size	Part#	Price
1-1/2"	32101507	\$123.60
2"	32102007	\$125.80
3"	32103007	\$336.50
4"	32104007	\$606.20

**SINGLE WYE - 45Y**

Size	Part#	Price
1-1/2"	32101508	\$110.20
2"	32102008	\$178.90
3"	32103008	\$317.80
4"	32104008	\$500.40
6"	32106008	\$1,057.90

**REDUCING WYE**

Size	Part#	Price
2" x 1-1/2"	321021509	\$123.60
3" x 1-1/2"	321031509	\$226.60
3" x 2"	321030209	\$240.50
4" x 1-1/2"	321041509	\$430.60
4" x 2"	321040209	\$442.80
4" x 3"	321040309	\$454.90
6" x 2"	321060209	\$1,152.90
6" x 3"	321060309	\$1,165.00
6" x 4"	321060409	\$1,179.50

**LONG TURN TEE WYE - LTY**

Size	Part#	Price
1-1/2"	32101510	\$153.90
2"	32102010	\$222.90
3"	32103010	\$456.90
4"	32104010	\$823.50
6"	32106010	\$1,599.50

**REDUCING LONG TURN TEE WYE - RLTY**

Size	Part#	Price
2" x 1-1/2"	321021511	\$195.10
3" x 1-1/2"	321031511	\$287.20
3" x 2"	321030211	\$300.50
4" x 1-1/2"	321041511	\$469.30
4" x 2"	321040211	\$517.90
4" x 3"	321040311	\$609.70
6" x 2"	321060211	\$1,191.90
6" x 3"	321060311	\$1,309.30
6" x 4"	321060411	\$1,416.50

**DOUBLE WYE - D45Y**

Size	Part#	Price
1-1/2"	32101513	\$137.50
2"	32102013	\$256.20
3"	32103013	\$469.30
4"	32104013	\$637.10
6"	32106013	\$1,679.20

Attention: Do not pressure test with compressed air or gas! Severe damage or bodily injury can result.

PRICES SUBJECT TO CHANGE WITHOUT NOTICE, POSSESSION OF THIS PRICE LIST SHALL NOT BE CONSTRUED AS AN OFFER TO SELL TO THE BEARER.

<b>REDUCING DOUBLE WYE - RD45Y</b>			
	Size	Part#	Price
	2" x 1-1/2"	321021514	\$449.00
	3" x 1-1/2"	321031514	\$496.50
	3" x 2"	321030214	\$510.00
	4" x 1-1/2"	321041514	\$996.70
	4" x 2"	321040214	\$1,023.90
	4" x 3"	321040314	\$1,064.90
	6" x 2"	321060214	\$1,866.30
	6" x 3"	321060314	\$1,945.90
6" x 4"	321060414	\$1,973.20	

<b>DOUBLE LONG TURN TEE WYE - DLTY</b>			
	Size	Part#	Price
	1-1/2"	32101515	\$248.50
	2"	32102015	\$381.50
	3"	32103015	\$860.90
	4"	32104015	\$1,287.20
	6"	32106015	\$2,548.80

<b>DOUBLE REDUCING LONG TURN TEE WYE - RDLTY</b>			
	Size	Part#	Price
	2" x 1-1/2"	321021516	\$488.70
	3" x 1-1/2"	321031516	\$606.20
	3" x 2"	321030216	\$677.90
	4" x 1-1/2"	321041516	\$1,033.70
	4" x 2"	321040216	\$1,073.70
	4" x 3"	321040316	\$1,272.40
	6" x 2"	321060216	\$1,973.20
	6" x 3"	321060316	\$2,578.80
6" x 4"	321060416	\$2,756.10	

<b>MALE ADAPTER - MA</b>			
	Size	Part#	Price
	1-1/2"	32101517	\$46.50
	2"	32102017	\$55.80
	3"	32103017	\$94.40
	4"	32104017	\$135.10
	6"	32106017	\$324.10

<b>FEMALE ADAPTER - FA</b>			
	Size	Part#	Price
	1-1/2"	32101518	\$46.50
	2"	32102018	\$55.80
	3"	32103018	\$94.40
	4"	32104018	\$135.10
	6"	32106018	\$324.10

<b>CLEAN-OUT ADAPTER W/PLUG - COA</b>			
	Size	Part#	Price
	1-1/2"	32101519	\$85.10
	2"	32102019	\$103.40
	3"	32103019	\$199.40
	4"	32104019	\$287.90
	6"	32106019	\$690.70

<b>CAP (SOCKET TYPE)</b>			
	Size	Part#	Price
	1-1/2"	32101521	\$48.30
	2"	32102021	\$60.50
	3"	32103021	\$88.50
	4"	32104021	\$124.30
	6"	32106021	\$217.60

<b>REDUCING BUSHING - RB</b>			
	Size	Part#	Price
	2" x 1-1/2"	321021522	\$38.60
	3" x 1-1/2"	321031522	\$90.30
	3" x 2"	321030222	\$97.00
	4" x 1-1/2"	321041522	\$109.10
	4" x 2"	321040222	\$125.50
	4" x 3"	321040322	\$151.90
	6" x 2"	321060222	\$339.10
	6" x 3"	321060322	\$357.50
	6" x 4"	321060422	\$410.90

Attention: Do not pressure test with compressed air or gas! Severe damage or bodily injury can result.  
 PRICES SUBJECT TO CHANGE WITHOUT NOTICE, POSSESSION OF THIS PRICE LIST SHALL NOT BE CONSTRUED AS AN  
 OFFER TO SELL TO THE BEARER.

**REDUCING COUPLING - RCLS**



Size	Part#	Price
2" x 1-1/2"	321021551	\$43.70
3" x 1-1/2"	321031551	\$93.50
3" x 2"	321030251	\$109.70
4" x 1-1/2"	321041551	\$153.00
4" x 2"	321040251	\$163.60
4" x 3"	321040351	\$191.20
6" x 2"	321060251	\$339.10
6" x 3"	321060351	\$357.50
6" x 4"	321060451	\$410.90

**P TRAP - UTP**



Size	Part#	Price
1-1/2"	32101525	\$203.10
2"	32102025	\$263.80

**P TRAP - RBP**



Size	Part#	Price
1-1/2"	32101528	\$187.90
2"	32102028	\$215.40
3"	32103028	\$643.10
4"	32104028	\$1,152.60
6"	32106028	\$4,791.10

**RLNS**



Size	Part#	Price
1-1/2"	32101530	\$56.20
2"	32102030	\$80.50

**SINK TAIL PIECE EXTENSION - RLNS X 12**



Size	Part#	Price
1-1/2"	02101531	\$124.20
2"	02102031	\$177.40

**FLANGE - FLG**



Size	Part#	Price
1-1/2"	32101535	\$121.60
2"	32102035	\$193.20
3"	32103035	\$349.50
4"	32104035	\$524.50
6"	32106035	\$738.70

Blind Flanges Available  
Contact Orion

**BACKING RING**



Size	Part#	Price
1-1/2"	04001536	\$63.80
2"	04002036	\$70.60
3"	04003036	\$93.00
4"	04004036	\$111.70
6"	04006036	\$122.60

**ACID WASTE FLOOR CLEAN-OUTS\***



Size	Part#	Price
<u>Brushed Bronze Square</u>		
3"	02103044SBB	\$579.00
4"	02104044SBB	\$621.00
<u>Nickle Bronze Square</u>		
3"	02103044SNB	\$579.00
4"	02104044SNB	\$621.00
<u>Brushed Bronze Round</u>		
3"	02103044RBB	\$579.00
4"	02104044RBB	\$621.00
<u>Nickle Bronze Round</u>		
3"	02103044RBN	\$579.00
4"	02104044RBN	\$621.00

**FLOOR DRAIN - FD-1**



Size	Part#	Price
2" Socket	32102045	\$582.10
3" Socket	32103045	\$664.60
4" Socket	32104045	\$741.80

**FLOOR DRAIN ACCESSORIES**

Funnel - 4"x9"	02300065	\$94.70
1/2" Trap primer connection FIP	02000066	\$64.10
Sediment bucket	01300067	\$96.30
Flashing clamp	04000068	\$74.70
Vandal proofing	000000VP	\$108.90
Solid cover	02300069	\$121.60

Attention: Do not pressure test with compressed air or gas! Severe damage or bodily injury can result.  
PRICES SUBJECT TO CHANGE WITHOUT NOTICE, POSSESSION OF THIS PRICE LIST SHALL NOT BE CONSTRUED AS AN OFFER TO SELL TO THE BEARER.



# NEUTRALIZATION AND DILUTION TANKS

**Style 4, 5 & 7** All tanks are free standing and self supporting except 1200, which requires bracing or FRP wrap.

**Style 4**  
Welded Top



**Style 5**  
Bolted Top



+ FRP  
Style 7



+ TAF  
Tank Anchor Flange

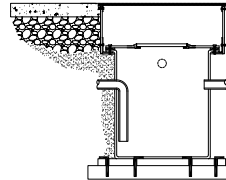

+ RAF  
Reinforcing Anchor Flange

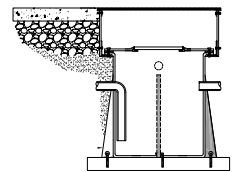

Standard Tank Pricing					Optional Extras			Dims In Inches			Limestone	
Style 4		Style 5			ADD TO STANDARD TANK PRICE			Ht.	Dia.	Std. Cover Dia.	Load In lbs	List Price
Gallons	Model #	List Price	Model #	List Price	+ FRP Style 7	+ TAF Tank Anchor Flange	+ RAF Reinforcing Anchor Flange					
5	4-222-5	\$535	5-222-5	\$530	\$365	\$223	\$246	16.25	11	16	50	\$43
15	4-332-15	\$1,175	5-332-15	\$766	\$1,058	\$234	\$263	15.5	17.25	22.25	150	\$128
30	4-332-30	\$1,440	5-332-30	\$1,048	\$1,228	\$251	\$279	30.5	17.25	22.25	250	\$212
55	4-332-55	\$1,723	5-332-55	\$1,284	\$1,502	\$267	\$298	33.5	22.5	27.5	500	\$424
100	4-443-100	\$1,988	5-443-100	\$1,610	\$2,210	\$305	\$338	49	24	29	1000	\$847
150	4-443-150	\$2,812	5-443-150	\$2,100	\$2,644	\$347	\$386	48	30	35	1700	\$1,441
180	4-443-180	\$3,464	5-443-180	\$2,712	\$2,770	\$356	\$393	42	36	41	2000	\$1,695
200	4-443-200	\$3,597	5-443-200	\$2,853	\$2,990	\$363	\$403	53	36	41	2500	\$2,119
275	4-443-275	\$3,985	5-443-275	\$3,343	\$3,333	\$388	\$431	48	42	47	3600	\$3,050
360	4-443-360	\$4,453	5-443-360	\$3,873	\$4,572	\$472	\$521	48	48	53	4500	\$3,814
500	4-443-500	\$6,015	5-443-500	\$5,421	\$5,190	\$582	\$642	60	52	57	6000	\$5,084
600	4-443-600	\$7,825	5-443-600	\$7,132	\$5,390	\$679	\$757	84	48	53	7500	\$6,356
1200	4-443-1200	\$13,817	5-443-1200	\$13,189	\$5,922	\$997	\$902	84	69	74	14500	\$12,288

Limestone is sold in 50 lbs. bags. List price is \$43 per bag.

Standard Inlet, Outlet & Vent Sizes (FIP)				*Standard Cleanout Access	
Gallons	Inlet	Outlet	Vent	Gallons	Cleanout Type
5	2"	2"	2"	5 - 100	4" Cleanout
15 - 55	3"	3"	2"	150 - 1200	Gamma Top
100 - 1200	4"	4"	3"	* Style 4 Only*	

### PRICING EXAMPLE: (ADDITIONAL OPTION PRICING)

For a 360-Gallon Style 5 Tank, with FRP, TAF, 1/8" steel x 1/2" plastic composite cover.  
Add standard tank price and additional options together.

360-Gallon Style 5 Tank	FRP	TAF	1/8" steel x 1/2" plastic composite cover
\$3,873	\$4,572	\$472	\$1,662

**Total Tank Price = \$10,579**

### PRICING EXAMPLE: (UP-SIZED CONNECTION PRICING)

For a 360-Gallon Style 5 Tank, with 6" FIP Inlet.

Add standard tank price and the difference in price of the standard connection from the desired connection.

360-Gallon Style 5 Tank	Desired Connection Size	Standard Connection Size	Added Difference
\$3,873	\$517	Minus → \$221	Equals → \$296

**Total Tank Price = \$4,169**

**Note: All tank orders must have submittal drawings.**

All Tanks F.O.B. factory. Tank orders are non-cancelable and non-returnable. Attention: Do not pressure test with compressed air or gas! Severe damage or bodily injury can result. PRICES SUBJECT TO CHANGE WITHOUT NOTICE, POSSESSION OF THIS PRICE LIST SHALL NOT BE CONSTRUED AS AN OFFER TO SELL TO THE BEARER.

## Style 5 Optional Cover (Add Prices To Standard Tank Price)

Gallons	Snap Ring	Flat Top		Load Bearing				Adjustable Height
		1/2" Thick Plastic Top	3/4" Thick Plastic Top	1/8" steel x 1/2" plastic composite cover	1/4 steel x 1/2 plastic composite cover	1/8" steel x 3/4" plastic composite cover	1/4 steel x 3/4 plastic composite cover	Extension 1/4 Steel Cover, 2" Adjustment
5	-	\$198	\$218	\$949	\$987	\$996	\$1,037	\$1,685
15	\$22	\$295	\$323	\$949	\$987	\$996	\$1,037	\$2,181
30	\$22	\$297	\$326	\$949	\$987	\$996	\$1,037	\$2,181
55	\$23	\$336	\$369	\$949	\$987	\$996	\$1,037	\$2,448
100	\$24	\$441	\$486	\$1,357	\$1,510	\$1,561	\$1,718	\$3,031
150	-	\$483	\$531	\$1,357	\$1,510	\$1,561	\$1,718	\$3,232
180	-	\$534	\$586	\$1,357	\$1,510	\$1,561	\$1,718	\$3,496
200	-	\$569	\$626	\$1,357	\$1,510	\$1,561	\$1,718	\$3,675
275	-	\$640	\$704	\$1,357	\$1,510	\$1,561	\$1,718	\$3,962
360	-	\$599	\$990	\$1,662	\$1,901	\$1,982	\$2,226	\$4,419
500	-	\$960	\$1,057	\$1,662	\$1,901	\$1,982	\$2,226	\$4,646
600	-	\$1,043	\$1,147	\$1,662	\$1,901	\$1,982	\$2,226	\$4,646
1200	-	\$1,433	\$1,577	\$3,040	\$3,661	\$3,864	\$4,485	P.O.A

## Optional Connections & Access Ports (Add Prices To Standard Tank Price)

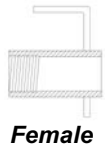

Female



Male



Plain End

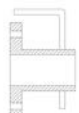

Flange

Inlet, Outlet & Vent FIP Connection			Inlet, Outlet & Vent Male Connection		
Inlet			Inlet		
Fitting Size	w/Invert Price Ea.	Outlet/Vent Price Ea.	Fitting Size	w/Invert Price Ea.	Outlet/Vent Price Ea.
1 1/2"	\$65	\$18	1 1/2"	\$65	\$18
2"	\$82	\$22	2"	\$82	\$22
3"	\$144	\$35	3"	\$144	\$35
4"	\$221	\$67	4"	\$221	\$67
6"	\$517	\$182	6"	\$517	\$182

Inlet, Outlet & Vent Plain End Connection			Inlet, Outlet & Vent Flange Connection		
Inlet			Inlet		
Fitting Size	w/Invert Price Ea.	Outlet/Vent Price Ea.	Fitting Size	w/Invert Price Ea.	Outlet/Vent Price Ea.
1 1/2"	\$56	\$7	1 1/2"	\$176	\$128
2"	\$67	\$10	2"	\$229	\$171
3"	\$127	\$18	3"	\$342	\$234
4"	\$176	\$22	4"	\$432	\$279
6"	\$380	\$44	6"	\$688	\$353

Access Port		
Access Port Type	Applicable Tanks	Price Each
3" Cleanout	5 - 1200	\$123
4" Cleanout	5 - 1200	\$175
6" Cleanout	5 - 1200	\$224
Gamma Top 12"	5 - 1200	\$162
Gamma Plus 16"	55 - 1200	\$228
20" Manway x 1/2"	150 - 1200	\$362
20" Manway x 3/4"	150 - 1200	\$362
24" Manway x 1/2"	150 - 1200	\$435
24" Manway x 3/4"	150 - 1200	\$479



Maintenance Sign	
Description	List Price
17" Wide x 11" High	\$288

**IMPORTANT**  
 FOLLOW MAINTENANCE PROCEDURES WITH TANK. FAILURE TO DO SO CAN RESULT IN DAMAGE TO THE PIPING SYSTEMS.  
 FOR FURTHER INFORMATION CALL 1-913-342-1653

## Tank Extensions

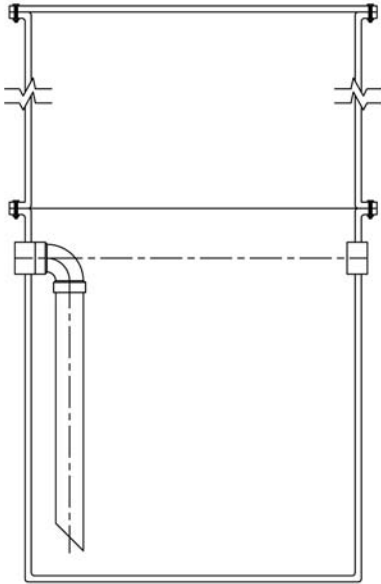

Gallons	Std. Tank Ht.	Single Lift Ext. Min/Max	Single Lift Ext. Total Height Min/Max	Single Lift Ext. List Price	Double Lift Ext. Min/Max	Double Lift Ext. List Price
5	16.25	4 / 14	20.25 / 30.25	\$530	24.25 / 44.25	\$1,060
15	15.5	4 / 14	19.5 / 29.5	\$766	23.5 / 43.5	\$1,531
30	30.5	4 / 28	34.5 / 58.5	\$1,048	38.5 / 86.5	\$2,097
55	33.5	4 / 31	37.5 / 64.5	\$1,284	41.5 / 95.5	\$2,567
100	49	4 / 47	53 / 96	\$1,610	57 / 143	\$3,221
150	48	4 / 46	52 / 94	\$2,100	56 / 140	\$4,200
180	42	4 / 40	46 / 82	\$2,712	50 / 122	\$5,423
200	53	4 / 51	57 / 104	\$2,853	61 / 144	\$5,707
275	48	4 / 46	52 / 94	\$3,343	56 / 140	\$6,686
360	48	4 / 46	52 / 94	\$3,873	56 / 140	\$7,746
500	60	4 / 58	64 / 118	\$5,421	68 / 144	\$10,842
600	84	4 / 58	88 / 142	\$7,132	92 / 144	\$14,265
1200	84	4 / 36	88 / 120	\$13,189	92 / 144	\$26,378

All Dimensions In Inches

Note: All prices for tanks and tank options are listed separately. For tank extensions with FRP wrap, FRP wrap prices on page 30 must be added for the standard tank and for each extension.

## Rectangular Tanks

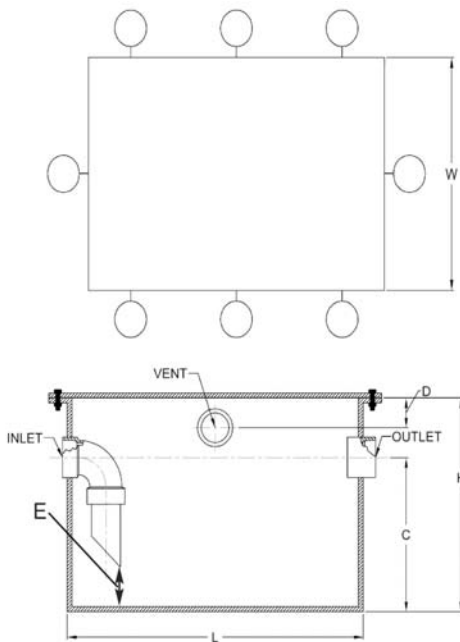

Part #	Size	L	W	H	C	D	E	List Price
ORT0001	1 Gal.	6"	12"	6"	3"	1.5"	2"	\$370
ORT0002	2 Gal.	8"	8"	8"	5"	1.5"	2"	\$400
ORT0005	5 Gal.	10"	16"	8"	5"	1.5"	2"	\$607
ORT0015	15 Gal.	12"	24"	12"	7"	2"	4"	\$759
ORT0030	30 Gal.	12"	24"	24"	18"	2"	4"	\$888
ORT0055	55 Gal.	24"	30"	18"	12"	2"	4"	\$1,569
ORT0115	115 Gal.	30"	30"	30"	24"	2"	4"	\$1,819
ORT0150	150 Gal.	24"	48"	30"	24"	2"	4"	\$2,038
ORT0215	215 Gal.	36"	36"	42"	36"	2"	4"	\$3,975
ORT0265	265 Gal.	36"	72"	24"	18"	2"	4"	\$4,309
ORT0540	540 Gal.	36"	72"	48"	42"	2"	4"	\$5,841
ORT0670	670 Gal.	36"	72"	60"	54"	2"	4"	\$5,917

Note: Rectangular tanks with heights greater than 18" require external supports.

**Note: All tank orders must have submittal drawings.**

All Tanks F.O.B. factory. Tank orders are non-cancelable and non-returnable. Attention: Do not pressure test with compressed air or gas! Severe damage or bodily injury can result. PRICES SUBJECT TO CHANGE WITHOUT NOTICE, POSSESSION OF THIS PRICE LIST SHALL NOT BE CONSTRUED AS AN OFFER TO SELL TO THE BEARER.

## Double Wall Tanks

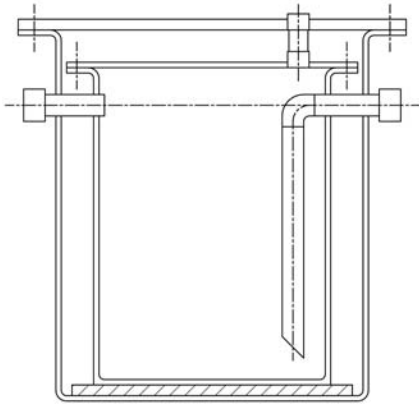

Gallons Carrier/Containment	List Price
5/30	\$1,896
15/55	\$2,460
30/55	\$2,800
55/150	\$4,061
100/200	\$5,356
150/200	\$5,944
180/360	\$7,902
200/500	\$9,930
275/600	\$12,571
360/1200	\$20,475
500/1200	\$20,921
600/1200	\$24,387

Variations in tank sizing can be manufactured, please contact Orion for more information.

## Solids Interceptors

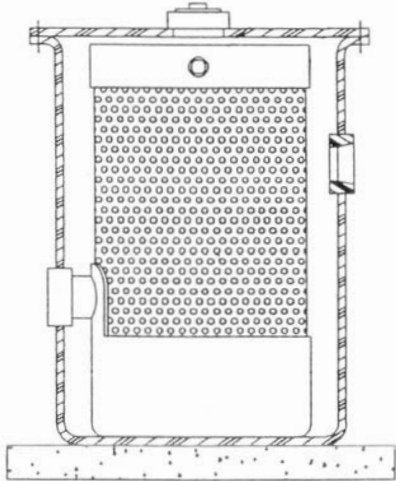

Part #	Tank Size	List Price
SI-5PB	5 Gallon	\$1,002
SI-15PB	15 Gallon	\$1,299
SI-55PB	55 Gallon	\$1,873

## Decontamination Tanks

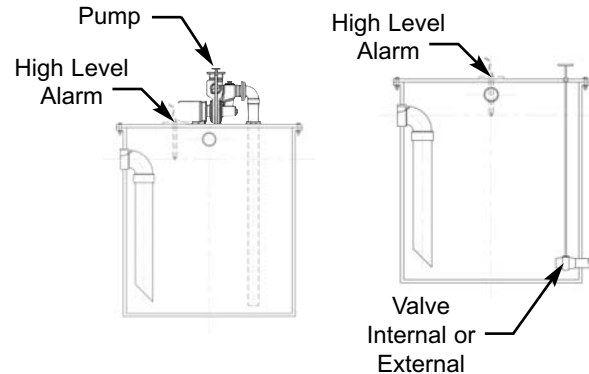

Tank Size	List Price
150 Gallon	P.O.A.
200 Gallon	P.O.A.
275 Gallon	P.O.A.
360 Gallon	P.O.A.
500 Gallon	P.O.A.
600 Gallon	P.O.A.
1200 Gallon	P.O.A.

Decontamination & Holding Tank Collects & Stores Chemical Waste.

## Tank Isolation Drain Valve



Part #	Size	Port Size	List Price
V075	3/4"	3/4"	\$123
V100FP	1"	1"	\$136
V150	1 1/2"	1 1/2"	\$176
V200FP	2"	2"	\$246
V300FP	3"	3"	\$590
V400	4"	3 1/2"	\$1,188

**Note: All tank orders must have submittal drawings.**

All Tanks F.O.B. factory. Tank orders are non-cancelable and non-returnable. Attention: Do not pressure test with compressed air or gas! Severe damage or bodily injury can result. PRICES SUBJECT TO CHANGE WITHOUT NOTICE, POSSESSION OF THIS PRICE LIST SHALL NOT BE CONSTRUED AS AN OFFER TO SELL TO THE BEARER.

# Trap Doors

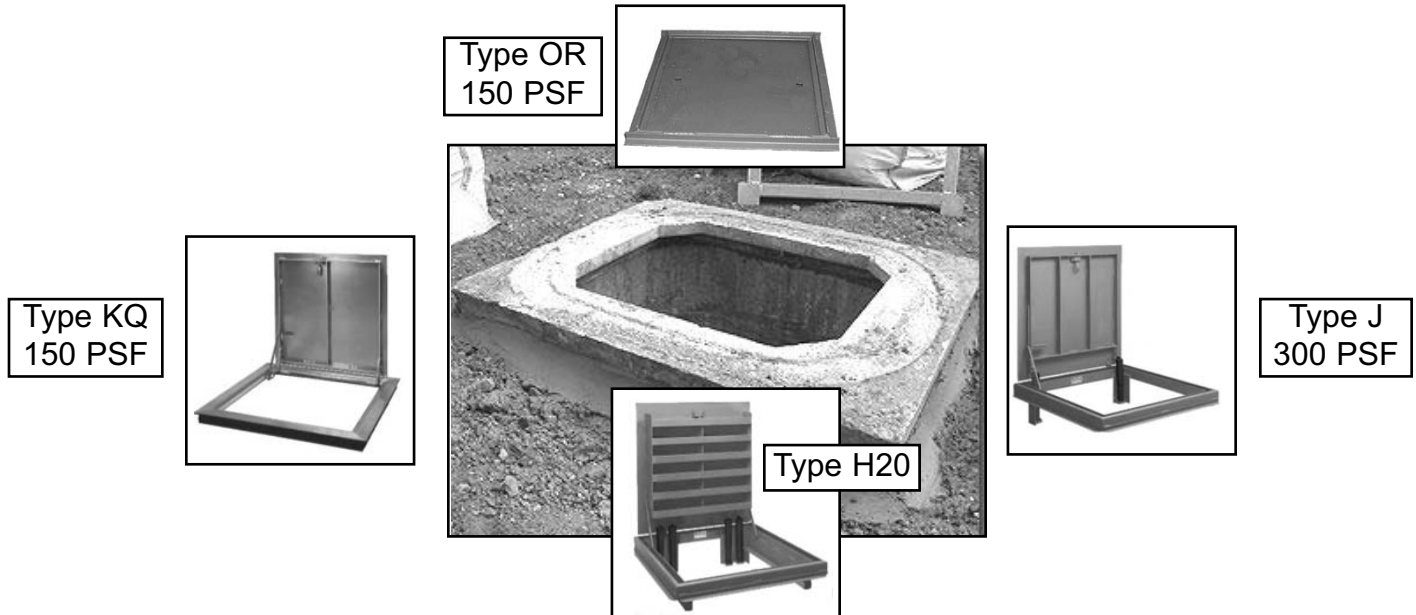

<b>TYPE OR: 150 PSF Steel, Loose Cover</b>			<b>TYPE K / TYPE Q: 150 PSF Hinged Cover</b>			
Model	Dimensions	List Price	Model	Model	Dimensions	List Price
OR-24	24"X24"	\$1,308	AL	Steel		
OR-36	36"X36"	\$1,736	K1	Q1	24"X24"	POA
OR-48	48"X48"	\$2,167	K4	Q4	36"X36"	POA
			KD2	QD2	48"X48"	POA
			KD4	N/A	60"X60"	POA

"D" represents a double door version

<b>TYPE J: 300 PSF Hinged Cover</b>				<b>TYPE JH20: H-20 Wheel Loading</b>			
Model	Model			Model			
AL	Steel	Dimensions	List Price	Steel	Dimensions	List Price	
J1AL	J1	24"X24"	POA	J1H20	24"X24"	POA	
J4AL	J4	36"X36"	POA	J4H20	36"X36"	POA	
JD2AL	JD2	48"X48"	POA	JD2H20	48"X48"	POA	
JD4AL	JD4	60"X60"	POA	JD4H20	60"X60"	POA	

"D" represents a double door version

<b>Suggested Trap Door Sizes For Orion Standard Tanks</b>	
Tank Size	Trap Door Size
5, 15, 30 galls	24"x24"
55, 100 galls	36"x36"
150, 180, 200 galls	48"x48"
275, 360, 500, 1200	60"x60"

**Note: All tank orders must have submittal drawings.**

All Tanks F.O.B. factory. Tank orders are non-cancelable and non-returnable. Attention: Do not pressure test with compressed air or gas! Severe damage or bodily injury can result. PRICES SUBJECT TO CHANGE WITHOUT NOTICE, POSSESSION OF THIS PRICE LIST SHALL NOT BE CONSTRUED AS AN OFFER TO SELL TO THE BEARER.

# Point Of Use Dilution & Neutralization Tanks & Traps



**Style 8** Dilution Tank or Trap

Capacity	Inlet-Outlet	Inside Dimensions	List Price
1.5 gal	1-1/2" FIP	12.3"x9"x6"	\$333.70
1.5 gal	2" FIP	12.3"x9"x6"	\$333.70



**Style 9** Neutralization or Dilution Tank

Capacity	Inlet-Outlet	Dimensions	List Price
5 gal	1-1/2" FIP	15" Dia.x12"	\$454.90
5 gal	2" FIP	15" Dia.x12"	\$454.90



**Style 10** Dilution Trap  
1-1/2 Gallon

Part #	Description	Price
OF59155-200	2- 1-1/2" inlets 1- 2" outlet	\$410.20
OF59155-201	1- 1-1/2" inlet 1- 2" outlet	\$407.20
OF59155-202	1- 2" inlet 1- 2" outlet	\$571.70
OF59155-203	2- 2" inlets 1- 2" outlet	\$587.30

To order a white tank, use (56) in place of 55



**Style 11** Anti-Siphon Dilution Trap  
1-1/2" Connections

Part #	Description	Price
OF31586-151	1 gallon	\$274.10
OF31586-152	2 gallon	\$297.60
OF31586-153	5 gallon	\$313.20



**Style 12** Dilution Trap

Capacity	Part #	Description	List Price
6 gal	OF32505-150	1-1/2 " inlet/outlet	\$391.55
6 gal	OF32505-200	2" Inlet/Outlet	\$430.70



**Style 13** Bookshelf Tank  
1-1/2" or 2" Connections

Part #	Description	Price
OF121206-001	3 gallon	\$443.70
OF181406-001	5 gallon	\$456.70

**Note: All tank orders must have submittal drawings.**

All Tanks F.O.B. factory. Tank orders are non-cancelable and non-returnable. Attention: Do not pressure test with compressed air or gas! Severe damage or bodily injury can result. PRICES SUBJECT TO CHANGE WITHOUT NOTICE, POSSESSION OF THIS PRICE LIST SHALL NOT BE CONSTRUED AS AN OFFER TO SELL TO THE BEARER.

# Neutraguard pH Monitoring and Data Logging Systems

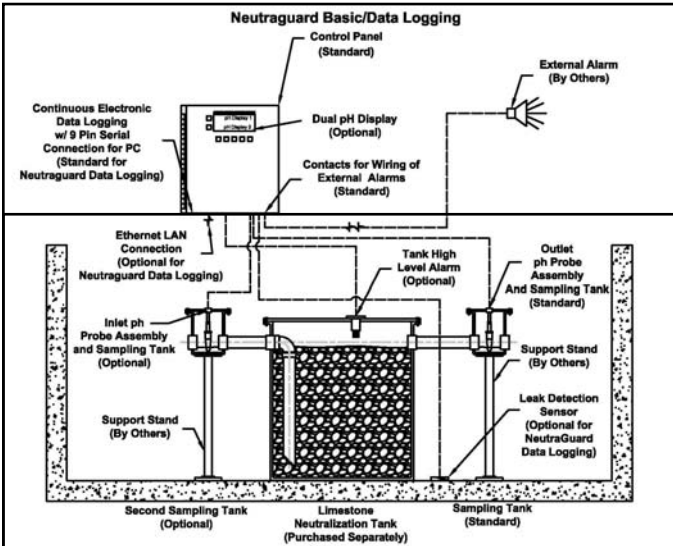

**Neutraguard Monitor;  
Model M02-0-01-000** \$9,969

Includes panel, pH probe, sampling tank, dry contacts for building management system, digital controls and display, high / low level pH alarms - audio & visual.

**Optional Extras**

- Second pH Probe Assembly & Display
- Tank High and/or Low Level Alarms

**Neutraguard Data Logger With Serial Port;  
Model M01-1-01-001:** \$13,324

Includes panel, pH probe, sampling tank, dry contacts for building management system, digital controls and display, high / low level pH alarms - audio & visual, digital data logger with 57,000 data points, 9 pin serial port connection, local data download capability

**Optional Extras**

- Second pH Probe Assembly & Display
- Tank High and/or Low Level Alarms
- Memory Expansion Modul

**Neutraguard Data Logger With Ethernet Port;  
Model M01-1-01-002:** \$15,191

Includes panel, pH probe, sampling tank, dry contacts for building management system, digital controls and display, high / low level pH alarms - audio & visual, digital data logger with 57,000 data points, 9 pin serial port connection, local data download capability, ethernet remote data download, real time data logging.

**Optional Extras**

- Second pH Probe Assembly & Display
- Tank High and/or Low Level Alarms
- Memory Expansion Modul

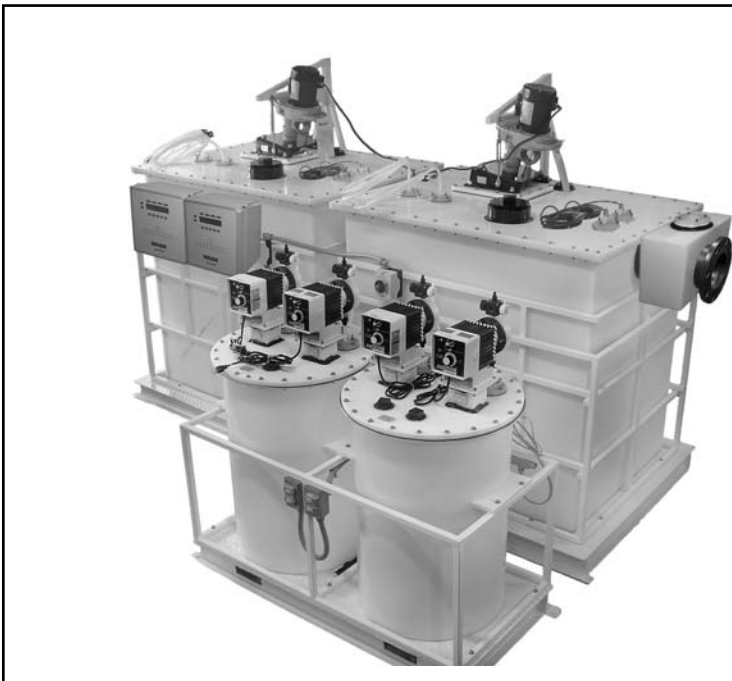

**Neutraguard Chemical Doser: POA**

Includes panel, pH probe, sampling tank, dry contacts for building management system, digital controls and display, high / low level pH alarms - audio & visual, digital data logger with 57,000 data points, 9 pin serial port connection, local data download capability, ethernet remote data download, real time data logging, metering pumps, reagent tanks and alarms.

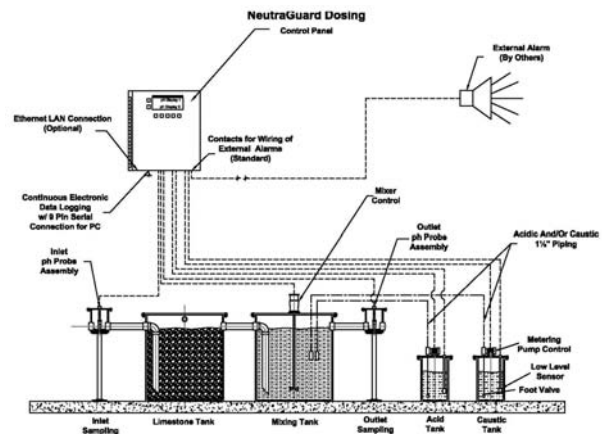

**Note: All tank orders must have submittal drawings.**

All Tanks F.O.B. factory. Tank orders are non-cancelable and non-returnable. Attention: Do not pressure test with compressed air or gas! Severe damage or bodily injury can result. PRICES SUBJECT TO CHANGE WITHOUT NOTICE, POSSESSION OF THIS PRICE LIST SHALL NOT BE CONSTRUED AS AN OFFER TO SELL TO THE BEARER.















